

LCD Digital Colour TV



Operating Instructions

- ⚠ Before operating the TV, please read the “Safety information” section of this manual.
Retain this manual for future reference.

KDL-52XBR KDL-52X3100
KDL-46XBR KDL-46X3100
KDL-40XBR KDL-40X3100

BRAVIA

XBR

Introduction

Thank you for choosing this Sony product.
Before operating the TV, please read this manual thoroughly and retain it for future reference.

Trademark information

- **DVB** is a registered trademark of the DVB Project
- “Dolby” and the double-D symbol are trademarks of Dolby Laboratories.
Manufactured under license from Dolby Laboratories.
- HDMI, the HDMI logo and High-Definition Multimedia Interface are trademarks or registered trademarks of HDMI Licensing LLC.
- Adobe is a registered trademark or a trademark of Adobe Systems Incorporated in the United States and/or other countries.



The illustrations used in this manual are of the KDL-40XBR unless otherwise stated.

Table of Contents

Start-up Guide

4

Safety information	9
Precautions	11
Overview of the remote	12
Overview of the TV buttons and indicators	13

Watching TV

Watching TV	14
Using the Favourite List DVB	17

Using Optional Equipment

Connecting optional equipment.....	18
Viewing pictures from the connected equipment	21
Using the remote	22
Using USB photo viewer	25
Using HDMI control	25

Using Menu Functions

Navigating through menus	26
Picture menu	27
Sound menu	29
Screen menu (except for PC input)	31
Screen menu (for PC input)	32
Video Settings menu	33
Audio Settings menu	35
Set-up menu.....	36
Analogue Set-up menu	39
Digital Set-up menu DVB	41

Additional Information

Specifications	43
Cleaning	45
Troubleshooting	45

DVB : for digital channels only

Start-up Guide

1: Checking the accessories

AC power cord* (1)

Antenna cable* (1)

PC cable* (1)

Support belt (1) and screws (2)

Remote RM-GD003 (1)

Size AA batteries (R6 type) (2)

* Do not remove the ferrite cores.

To insert batteries into the remote

Push and slide to open.

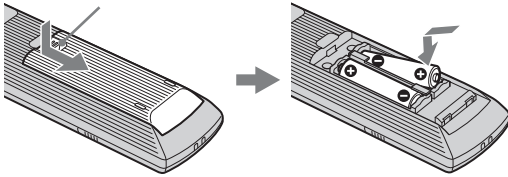

- Observe the correct polarity when inserting batteries.
- Do not use different types of batteries together or mix old and new batteries.
- Dispose of batteries in an environmentally friendly way. Certain regions may regulate the disposal of batteries. Please consult your local authority.
- Handle the remote with care. Do not drop or step on it, or spill liquid of any kind onto it.
- Do not place the remote in a location near a heat source, a place subject to direct sunlight, or a damp room.

To replace the bezel unit (only for KDL-52X3100/46X3100/40X3100)

The bezel unit can be replaced with others that are sold separately. However, do not remove the unit except to replace it. For details, see the instructions supplied with bezel units.

2: Connecting an antenna/VCR

Connecting an antenna

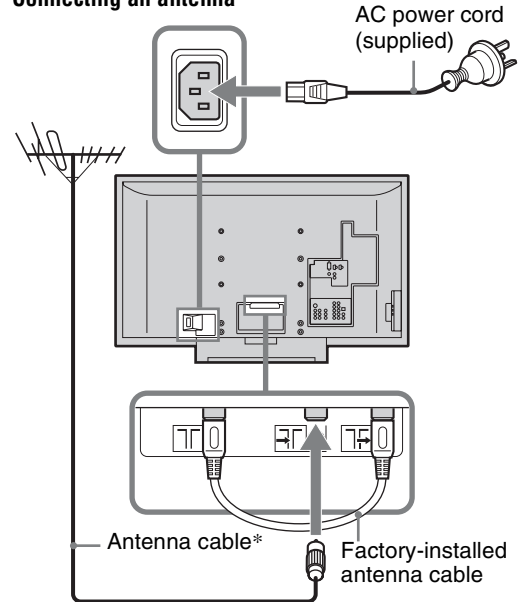

- * When connecting an antenna cable, an adaptor (not supplied) may be required.

Connecting an antenna and VCR

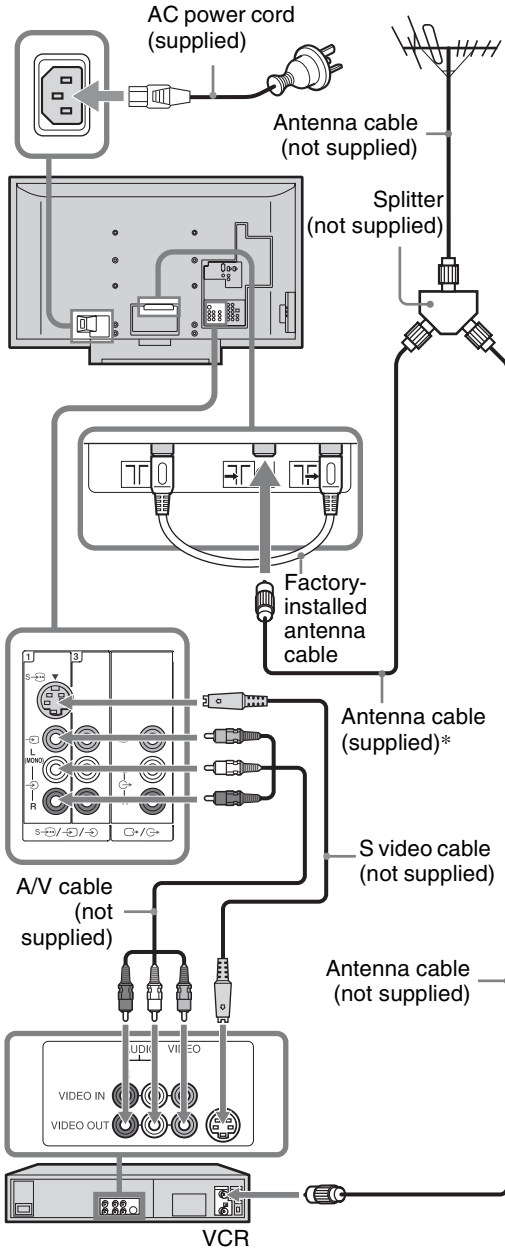

* When connecting an antenna cable, an adaptor (not supplied) may be required.

3: Preventing the TV from toppling over

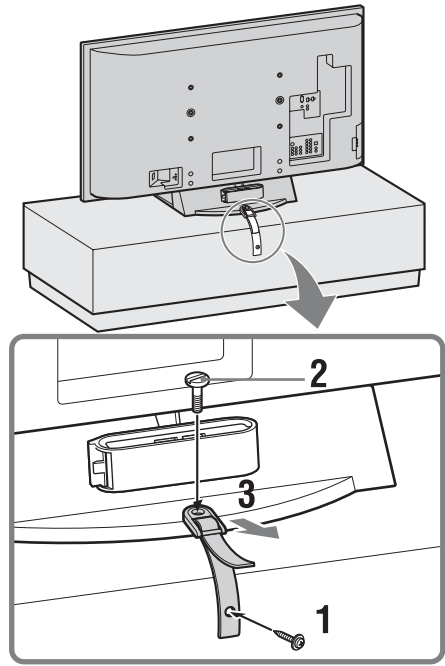

4: Bundling the cables

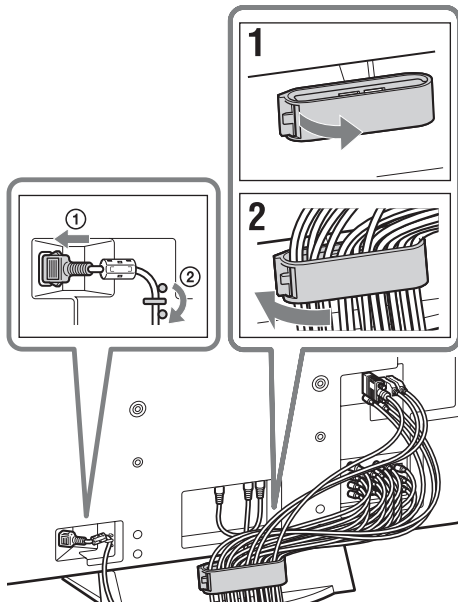

The hook of the cable holder can be opened from either sides depending on attaching position.

5: Performing the initial set-up

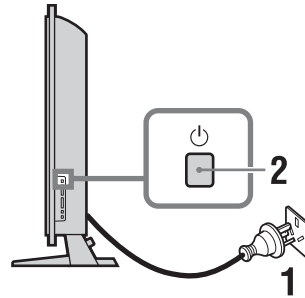

Selecting the state/region

- 1 Connect the TV to your AC power outlet (220–240 V AC, 50 Hz).
- 2 Press  on the right side of the TV. When you turn on the TV for the first time, the Time Setup menu appears on the screen.

- 3 Press $\uparrow/\downarrow/\leftarrow/\rightarrow$ to select the state/region in which you will operate the TV, then press \oplus .

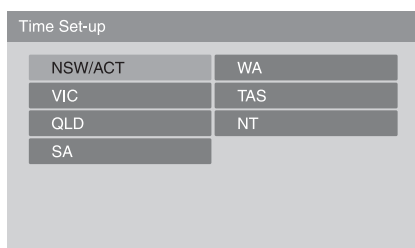

This option allows you to set the time zone in which you will operate the TV. This will ensure that the time displayed on the i-Plate (page 16) is correct.

Auto-tuning the TV

- 4 Press \uparrow/\downarrow to select “Full Scan” or “Quick Scan” to preset channels, then press \oplus .

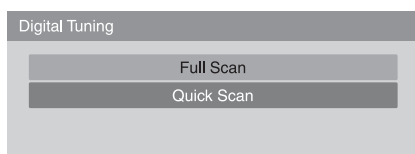

“Full Scan”: All available channels are tuned and stored. This procedure may take some time.

“Quick Scan”: All expected channels in your area are tuned and stored. You will need to select your nearest city to help speed up this procedure.

- 5 Press \leftarrow/\rightarrow to select “OK”, then press \oplus .

A display appears showing a tuning progress bar and the channels tuned and stored.

The TV starts searching for all available digital channels, followed by all available analogue channels. This may take some time, please be patient and do not press any buttons on the TV or remote.

If a message appears for you to confirm the antenna connection

No digital or analogue channels were found. Check the antenna connection and press \leftarrow/\rightarrow to select “Yes”, then press \oplus to start auto-tuning again.

- 6 When the Programme Sorting menu appears on the screen, follow the steps of “Programme Sorting” (page 39).

If you do not change the order in which the analogue channels are stored on the TV, go to step 7.

- 7 Press MENU to display the Clock Set menu.

When digital channels have been stored, set “Time Adjustment” to “Auto”, then go to step 9. If no digital channels have been stored, set “Time Adjustment” to “Manual”, then go to next step.

- 8 Press $\uparrow/\downarrow/\leftarrow/\rightarrow$ to set the day and time (hour and minute), then press \oplus .

- 9 Press MENU to exit.

The TV has now tuned in all the available channels.

- 10 Press \leftarrow/\rightarrow to select the desired setting in “Display this menu next time ?” dialogue, then press \oplus to exit.



If “Yes” is selected and the TV is turned off by pressing \downarrow on the TV, or is disconnected from the AC power outlet, the auto start-up procedure restarts the next time the TV is turned on.

Detaching the Table-Top Stand from the TV



Do not remove the Table-Top Stand for any reason other than to wall-mount the TV or to attach the optional TV stand.

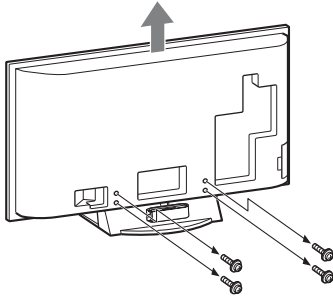

Safety information

Installation/Set-up

Install and use the TV set in accordance with the instructions below in order to avoid any risk of fire, electrical shock or damage and/or injuries.

Installation

- The TV set should be installed near an easily accessible AC power outlet.
- Place the TV set on a stable, level surface.
- Only qualified service personnel should carry out wall installations.
- For safety reasons, it is strongly recommended that you use Sony accessories, including:
 - Wall-mount bracket SU-WL500

Transporting

- Before transporting the TV set, disconnect all cables.
- Two or three people are needed to transport a large TV set.
- When transporting the TV set by hand, hold it as shown on the right. Do not put stress on the LCD panel and the frame around the screen.
- When lifting or moving the TV set, hold it firmly from the bottom.
- When transporting the TV set, do not subject it to jolts or excessive vibration.
- When transporting the TV set for repairs or when moving, pack it using the original carton and packing material.

KDL-46XBR/46X3100/
40XBR/40X3100

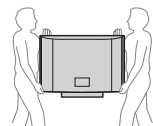

KDL-52XBR/52X3100

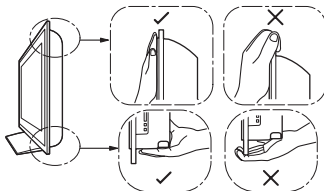

Ventilation

- Never cover the ventilation holes or insert anything in the cabinet.
- Leave space around the TV set as shown below.
- It is strongly recommended that you use a Sony wall-mount bracket in order to provide adequate air-circulation.

Installed on the wall

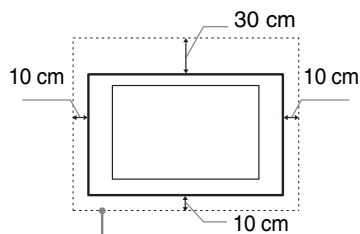

Leave at least this space around the set.

Installed with stand

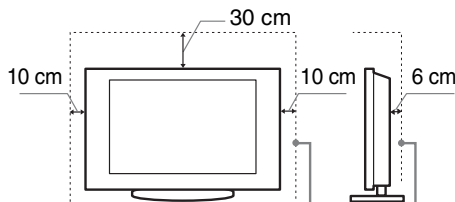

Leave at least this space around the set.

- To ensure proper ventilation and prevent the collection of dirt or dust:
 - Do not lay the TV set flat, install upside down, backwards, or sideways.
 - Do not place the TV set on a shelf, rug, bed or in a closet.
 - Do not cover the TV set with a cloth, such as curtains, or items such as newspapers, etc.
 - Do not install the TV set as shown below.

Air circulation is blocked.

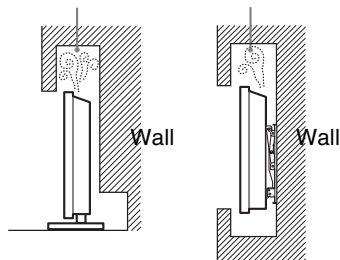

AC power cord

Handle the AC power cord and outlet as follows in order to avoid any risk of fire, electrical shock or damage and/or injuries:

- Connect the TV set using a three-wire grounding type AC power plug to a AC power outlet with a protective earthing connection.
- Use only Sony AC power cords, not those of other brands.
- Insert the plug fully into the AC power outlet.
- Operate the TV set on a 220–240 V AC supply only.
- When wiring cables, be sure to unplug the AC power cord for your safety and take care not to catch your feet on the cables.
- Disconnect the AC power cord from the AC power outlet before working on or moving the TV set.
- Keep the AC power cord away from heat sources.
- Unplug the AC power plug and clean it regularly. If the plug is covered with dust and it picks up moisture, its insulation may deteriorate, which could result in a fire.

Continued

Notes

- Do not use the supplied AC power cord on any other equipment.
- Do not pinch, bend, or twist the AC power cord excessively. The core conductors may be exposed or broken.
- Do not modify the AC power cord.
- Do not put anything heavy on the AC power cord.
- Do not pull on the AC power cord itself when disconnecting the AC power cord.
- Do not connect too many appliances to the same AC power outlet.
- Do not use a poor fitting AC power outlet.

Prohibited Usage

Do not install/use the TV set in locations, environments or situations such as those listed below, or the TV set may malfunction and cause a fire, electrical shock, damage and/or injuries.

Location:

Outdoors (in direct sunlight), at the seashore, on a ship or other vessel, inside a vehicle, in medical institutions, unstable locations, near water, rain, moisture or smoke.

Environment:

Places that are hot, humid, or excessively dusty; where insects may enter; where it might be exposed to mechanical vibration, near flammable objects (candles, etc). The TV shall not be exposed to dripping or splashing and no objects filled with liquids, such as vases, shall be placed on the TV.

Situation:

Do not use when your hands are wet, with the cabinet removed, or with attachments not recommended by the manufacturer. Disconnect the TV set from AC power outlet and antenna during lightning storms.

Broken pieces:

- Do not throw anything at the TV set. The screen glass may break by the impact and cause serious injury.
- If the surface of the TV set cracks, do not touch it until you have unplugged the AC power cord. Otherwise electric shock may result.

When not in use

- If you will not be using the TV set for several days, the TV set should be disconnected from the AC power for environmental and safety reasons.
- As the TV set is not disconnected from the AC power when the TV set is just turned off, pull the plug from the AC power outlet to disconnect the TV set completely.
- However, some TV sets may have features that require the TV set to be left in standby to work correctly. The instructions in this manual will inform you if this applies.

For children

- Do not allow children to climb on the TV set.
- Keep small accessories out of the reach of children, so that they are not mistakenly swallowed.

If the following problems occur...

Turn off the TV set and unplug the AC power cord immediately if any of the following problems occur. Ask your dealer or Sony service centre to have it checked by qualified service personnel.

When:

- AC power cord is damaged.
- Poor fitting of AC power outlet.
- TV set is damaged by being dropped, hit or having something thrown at it.
- Any liquid or solid object falls through openings in the cabinet.

Precautions

Viewing the TV

- View the TV in moderate light, as viewing the TV in poor light or during long period of time, strains your eyes.
- When using headphones, adjust the volume so as to avoid excessive levels, as hearing damage may result.

LCD Screen

- Although the LCD screen is made with high-precision technology and 99.99% or more of the pixels are effective, black dots may appear or bright points of light (red, blue, or green) may appear constantly on the LCD screen. This is a structural property of the LCD screen and is not a malfunction.
- Do not push or scratch the front filter, or place objects on top of this TV set. The image may be uneven or the LCD screen may be damaged.
- If this TV set is used in a cold place, a smear may occur in the picture or the picture may become dark. This does not indicate a failure. These phenomena disappear as the temperature rises.
- Ghosting may occur when still pictures are displayed continuously. It may disappear after a few moments.
- The screen and cabinet get warm when this TV set is in use. This is not a malfunction.
- The LCD screen contains a small amount of liquid crystal and mercury. The fluorescent tubes used in this TV set also contain mercury. Follow your local ordinances and regulations for disposal.

Handling and cleaning the screen surface/cabinet of the TV set

Be sure to unplug the AC power cord connected to the TV set from AC power outlet before cleaning.

To avoid material degradation or screen coating degradation, observe the following precautions.

- To remove dust from the screen surface/cabinet, wipe gently with a soft cloth. If dust is persistent, wipe with a soft cloth slightly moistened with a diluted mild detergent solution.
- Never use any type of abrasive pad, alkaline/acid cleaner, scouring powder, or volatile solvent, such as alcohol, benzene, thinner or insecticide. Using such materials or maintaining prolonged contact with rubber or vinyl materials may result in damage to the screen surface and cabinet material.
- When adjusting the angle of the TV set, move it slowly so as to prevent the TV set from moving or slipping off from its table stand.

Optional Equipment

Keep optional components or any equipment emitting electromagnetic radiation away from the TV set. Otherwise picture distortion and/or noisy sound may occur.

Disposal of Old Electrical & Electronic Equipment (Applicable in the European Union and other European countries with separate collection systems)



This symbol is on the remote control.

Overview of the remote

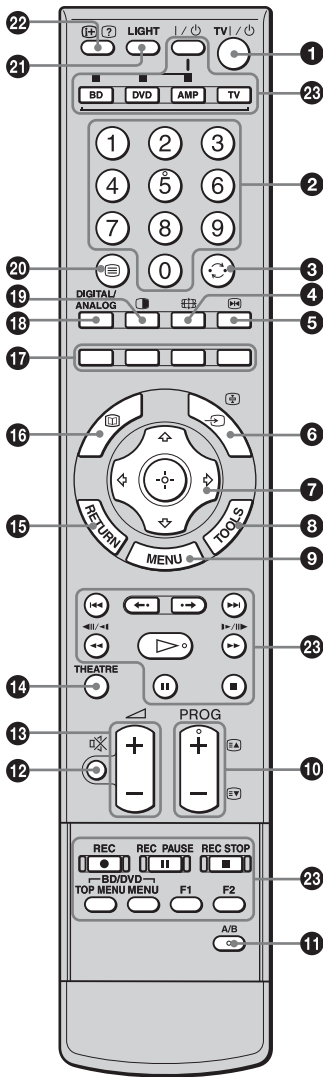

The number 5, \triangleright , PROG + and A/B buttons have tactile dots. Use the tactile dots as references when operating the TV.

- 1 TV I/⏻ — TV standby**
Turns the TV on and off from standby mode.
- 2 Number buttons**
 - In TV mode: Selects channels. For channel numbers 10 and above, enter the second, third or fourth digit quickly.
 - In Text mode: Enters the three digit page number to select the page.
- 3 ⏪ — Previous channel**
Returns to the previous channel watched (for more than five seconds).
- 4 📶 — Wide Mode (page 15)**
- 5 ⏸ — Picture freeze (page 14)**
Freezes the TV picture.
- 6 ↵/Ⓜ — Input select / Text hold**
 - In TV mode (page 21): Displays the connected equipment list and selects the input source.
 - In Text mode (page 14): Holds the current page.
- 7 ⬆/⬇/⬅/➡/⬆/⬇/⬅/➡/⊕ (page 26)**
- 8 TOOLS (page 15, 21)**
Enables you to access various viewing options and change/make adjustments according to the source and Wide Mode.
- 9 MENU (page 26)**
- 10 PROG +/-/Ⓜ/Ⓜ**
 - In TV mode (page 14): Selects the next (+) or previous (-) channel.
 - In Text mode (page 14): Selects the next (Ⓜ) or previous (Ⓜ) page.
- 11 A/B — Dual Sound (page 30)**
- 12 🚫 — Mute (page 14, 21)**
- 13 🔊 +/- — Volume (page 21)**
- 14 THEATRE**
You can set Theatre Mode on or off. When Theatre Mode is set to on, the optimum audio output (if the TV is connected with an audio system using an HDMI cable) and picture quality for film-based contents are automatically set.
💡
If you turn the TV off, Theatre Mode is also turned off.
- 15 RETURN**
Returns to the previous screen of any displayed menu.
- 16 📺**
This button does not work with this model.
- 17 Coloured buttons (page 14)**
- 18 DIGITAL/ANALOG — TV mode (page 14)**
- 19 🖥 — Twin Picture (page 21)/PIP (page 22) (for PC input)**
Displays two pictures simultaneously.
- 20 ☰ — Text (page 14)**
- 21 LIGHT**
Illuminates the buttons on the remote so that you can see them easily even if the room is dark.
- 22 Ⓜ/? — Info / Text reveal**
 - In digital mode (page 16): Displays details of the current or next programme.
 - In analogue mode: Displays information such as current channel number and Wide Mode.
 - In Text mode (page 14): Reveals hidden information (e.g. answers to a quiz).
- 23 Buttons for using optional equipment**
See page 22.

Overview of the TV buttons and indicators

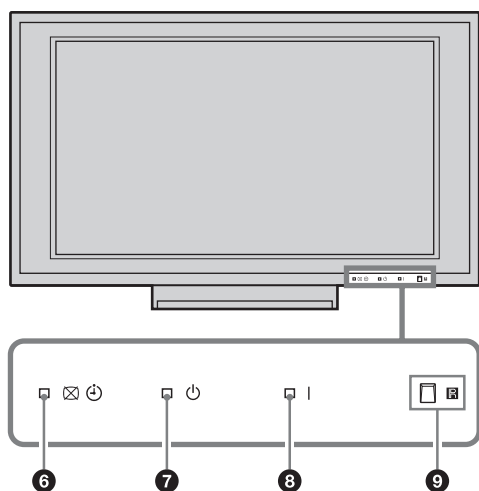
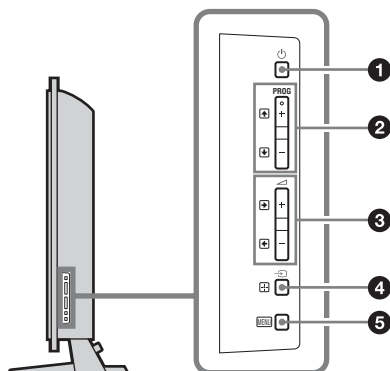

1 — Power

Turns the TV on or off.



To disconnect the TV from the AC power completely, pull the plug from the AC power outlet.

2 **PROG** +/-/↑/↓

- In TV mode: Selects the next (+) or previous (–) channel.
- In TV menu: Moves through the options up (↑) or down (↓).

3 +/-/↔/◀▶

- In TV mode: Increases (+) or decreases (–) the volume.
- In TV menu: Moves through the options right (▶) or left (◀).

4 — Input select / OK

- In TV mode (page 21): Displays the connected equipment list and selects the input source.
- In TV menu: Selects the menu or option, and confirms the setting.

5 **MENU** (page 26)

6 — Picture Off / Timer indicator

- Lights up in green when the picture is switched off (page 37).
- Lights up in orange when the timer is set (page 36).

7 — Standby indicator

Lights up in red when the TV is in standby mode.

8 **I** — Power indicator

- Lights up in green when the TV is turned on.
- Flashes while the remote is being operated.

9 **Remote control sensor / Light sensor** (page 37)

- Receives IR signals from the remote.
- Do not put anything over the sensor, as its function may be affected.



Make sure that the TV is completely turned off before unplugging the AC power cord. Unplugging the AC power cord while the TV is turned on may cause the indicator to remain lit or may cause the TV to malfunction.

Watching TV

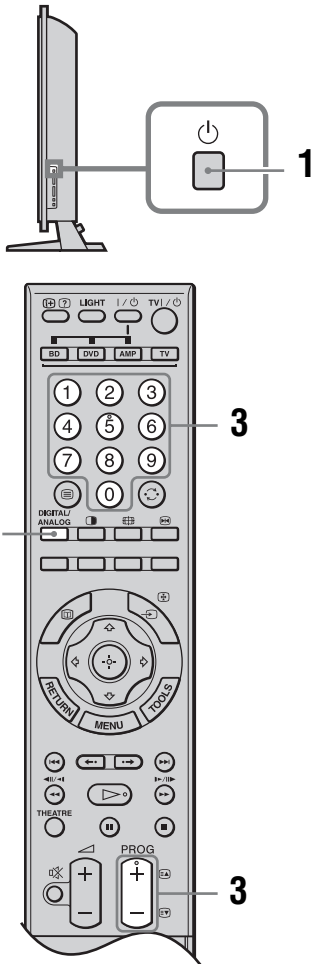

- 1 Press on the right side of the TV to turn on the TV.
When the TV is in standby mode (the (standby) indicator on the TV front panel is red), press TV on the remote to turn on the TV.
- 2 Press DIGITAL/ANALOG to switch between digital and analogue modes.
The channels available vary depending on the mode.

- 3 Press the number buttons or PROG +/- to select a TV channel.

To select channel numbers 10 and above using the number buttons, enter the second, third or fourth digits quickly.

In digital mode, an information banner appears briefly. The following icons may be indicated on the banner.

In normal TV mode

: SD (or : HD)

: Radio service

: Parental rating

: Multi audio programme

: Text service

In Twin Picture mode (page 21)

: Radio service

: Parental Lock

Additional operations

To	Press
Freeze the picture (Picture freeze)	. Press again to return to normal TV mode.
Mute the sound	. Press again to restore.
Turn on the TV without sound from standby mode	.

To access Text

Press . Each time you press , the display changes cyclically as follows:

Text and TV picture → Text → No Text (exit the Text service)

To select a page, press the number buttons or /.

To hold a page, press /.

To reveal hidden information, press /?.

To jump a page (in analogue mode only), press and , then press (for three digit pages).



When four coloured items appear at the bottom of the Text page, Fasttext is available (in analogue mode only). Fasttext allows you to access pages quickly and easily. Press the corresponding coloured button to access the page.

To change the Wide Mode manually

Press **WIDE** repeatedly to select the desired Wide Mode.

Wide Zoom*

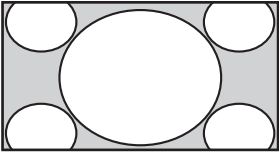

Enlarges the centre portion of the picture. The left and right edges of the picture are stretched to fill the 16:9 screen.

Normal

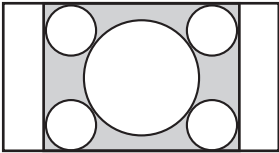

Displays the 4:3 picture in its original size. Side bars are shown to fill the 16:9 screen.

Full

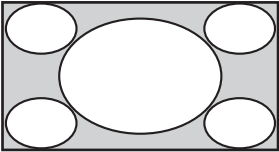

Stretches the 4:3 picture horizontally, to fill the 16:9 screen.

Zoom*

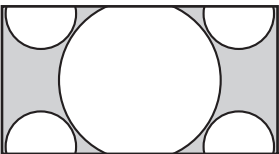

Displays cinemascopic (letter box format) broadcasts in the correct proportions.

* Parts of the top and bottom of the picture may be cut off.



- Some characters and/or letters at the top and the bottom of the picture may not be visible in “Wide Zoom”. In such a case, you can select “Vertical Size” using the “Screen” menu and adjust vertical size to make it visible.
- Wide Mode is fixed to “Full” in digital mode.
-  When “Auto Wide” is set to “On”, the TV will automatically select the best mode to suit the input from an external equipment (page 31).
- You can adjust the position of the picture when selecting “Wide Zoom” or “Zoom”. Press **UP**/**DOWN** to move up or down (e.g. to read subtitles).
- Select “Wide Zoom” or “Zoom” to adjust for 720p, 1080i or 1080p source pictures with edge portions cut off.
- “Full 1”, “Full 2” and “Normal” are available for “Wide Mode” when PC input is selected (page 32).

Using the Tools menu

Press **TOOLS** to display the following options when viewing a TV programme.

Options	Description
Close	Closes the Tools menu.
Picture Mode	See page 27.
Sound Mode	See page 29.
Motion Enhancer	See page 33.
Speaker	See page 35.
Twin Picture	See page 21.
Favourite List (in digital mode only)	See page 17.
PIP Programme List (in digital mode only)	See page 15.
 Volume	See page 35.
Sleep Timer	See page 36.
Power Saving	See page 37.

To view two pictures simultaneously – PIP (Picture in Picture) (in digital mode only)

This feature allows you to view a different sub-channel in a window and also access multiview services (when available from broadcaster, e.g. different camera angles).

- 1 Press **TOOLS** to display the Tools menu.
- 2 Press **UP**/**DOWN** to select “PIP Programme List”, then press **+**.
- 3 Press **UP**/**DOWN** to select the required channel/multiview service, then press **+**.

To return to normal TV mode

Select “PIP Programme List” from the Tools menu. Then, select “Close PIP”.



Depending on the broadcast signal, the image displayed on the PIP sub screen may be smaller than its frame size.

Continued

i-Plate display

For a single picture in digital mode, this feature gives you information on the current channel and also the current and next programmes.



1 Press /? to display the i-Plate.

This shows the date, time, whether the channel has text service, whether multi (MPEG and Dolby Digital) audio programme available and whether the picture is available in high definition or standard definition (HD or SD is displayed).

2 Press /? to display information on the following programme.

3 Press /? again (or MENU) to turn off the i-Plate display and return to normal operation.

The following icons may be displayed on the i-Plate display according to the programme.

: SD (or : HD)

: Parental rating

: Multi audio programme

: Text service



The code coming after MPEG determines the language type. For detail, refer to “i-Plate Display Language Code” on page 44.

Using the Favourite List DV3*



Favourite List

* This function may not be available in some areas.

The Favourite feature allows you to select programmes from a list you specify. To display the Favourite List, see “Navigating through menus” (page 26).

To	Do this
Create your Favourite List	Follow the steps of “Favourite Preset” (page 42) in Digital Set-up menu.
Watch a Favourite channel	<ol style="list-style-type: none">1 Press MENU to display the menu (page 26).2 Press \uparrow/\downarrow to select “Digital Favourites List”, then press \oplus.3 Press \leftarrow/\rightarrow to select “Favourite List 1” or “Favourite List 2”.4 Press \uparrow/\downarrow to select your favourite channel.5 Press \oplus to exit the Favourite List and display the selected channel. <p> Once you select a channel within your Favourite List of channels, pressing PROG +/- will select only channels from your Favourite List. To select a channel that has not been programmed as a Favourite List channel, use the Programme List feature or the number buttons.</p>
Turn off the Favourite list	Press MENU.

Connecting optional equipment

You can connect a wide range of optional equipment to your TV.

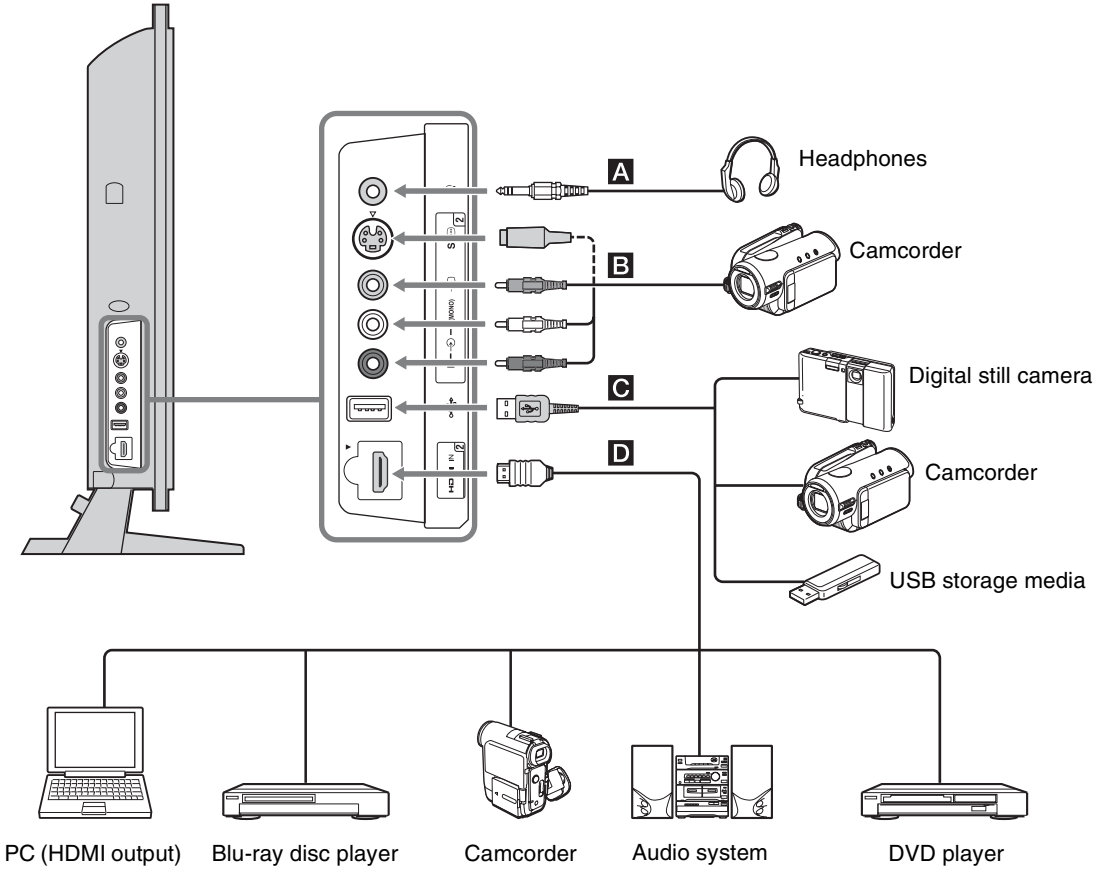

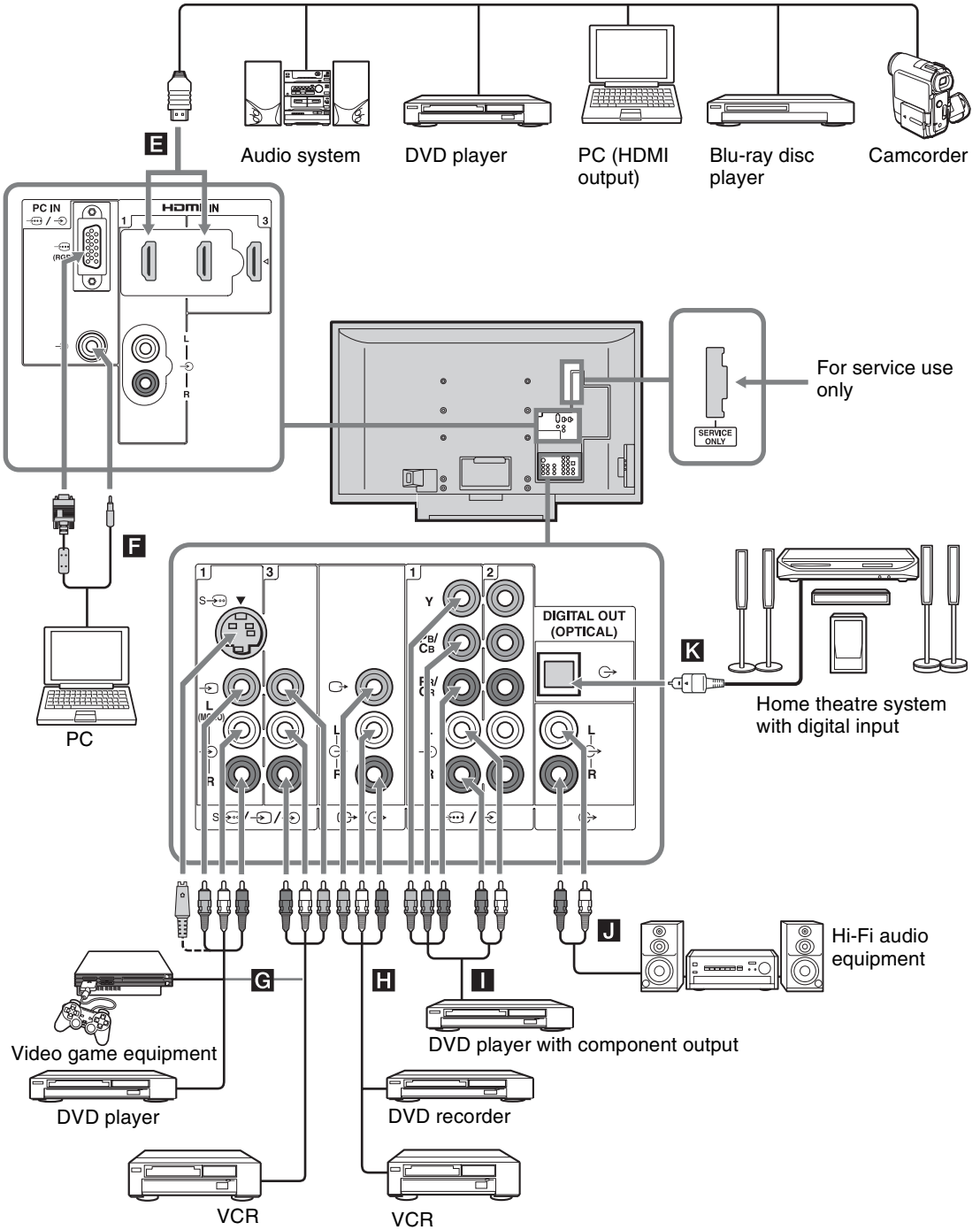





Continued



Connect to	Input symbol on screen	Description
A		You can listen to sound from the TV on headphones.
B S-Video 2 or Video 2, and Video 2	S-Video 2 or Video 2	To avoid picture noise, do not connect the camcorder to the video Video 2 jack and the S video S-Video 2 jack at the same time. If you connect mono equipment, connect to the Video 2 L jack.
C		You can view photographs on the Sony digital still camera, camcorder or USB storage media connected to the TV. For details, see page 25.
D HDMI IN 2 E HDMI IN 1 or 3	HDMI 2 HDMI 1 or HDMI 3	The digital video and audio signals are input from the equipment. In addition, when HDMI control compatible equipment is connected, communication with the connected equipment is supported. Refer to page 37 to set up this communication. If the equipment has a DVI jack, connect the DVI jack to the HDMI IN 1 jack through a DVI - HDMI adaptor interface (not supplied), and connect the equipment's audio out jacks to the audio in jacks in the HDMI IN 1 jacks. <ul style="list-style-type: none"> The HDMI jacks only support the following video inputs: 480i, 480p, 576i, 576p, 720p, 1080i, 1080p and 1080/24p. For PC video inputs, see page 44. Be sure to use only an HDMI cable that bears the HDMI logo. When connecting an HDMI control compatible audio system, be sure to also connect to the DIGITAL OUT (OPTICAL) jack.
F PC IN (RGB)/ 	PC	It is recommended to use a supplied PC cable with ferrite cores.
G S-Video 1 or Video 1 or 3, and Video 1 or 3	S-Video 1 or Video 1 or Video 3	To avoid picture noise, do not connect the camcorder to the video jack Video 1 and the S video jack S-Video 1 at the same time. If you connect mono equipment, connect to the L(MONO) jack Video 1 or 3.
H		Use to record the analogue video and sound from the TV to a DVD recorder or VCR. To turn off the sound of the TV speakers, set "Speaker" to "Audio System" (page 35). If you connect mono equipment, connect to the L jack . <ul style="list-style-type: none"> The monitor output jacks cannot support HD/DVD, HDMI and PC signals source pictures, also digital audio signal for sound. The images of digital broadcasting recorded on this TV appear enlarged when they are played on a 4:3 screen size TV that cannot be adjusted to other aspect modes.
I	HD/DVD 1 or HD/DVD 2	For better picture quality, component connection is recommended if your DVD player has a component video output.
J		You can listen to the sound from the TV on Hi-Fi audio equipment.
K DIGITAL OUT (OPTICAL)		Use the Optical audio cable.

Viewing pictures from the connected equipment

Turn on the connected equipment, then press  to display the connected equipment list. Press  to select the desired input source, then press . (The highlighted item is selected if 2 seconds pass without any operation after pressing .)

When the input source is set to “Skip” in the “Video Labels” menu under the “Set-up” menu (page 36), that input does not appear in the list.

Additional operations

To	Do this
Return to normal TV mode	Press DIGITAL/ANALOG.
Change the volume of the connected HDMI control compatible audio system	Press  +/-.
Mute the sound of the connected HDMI control compatible audio system	Press  . Press again to restore.

Using the Tools menu

Press TOOLS to display the following options when viewing pictures from connected equipment.

Options	Description
Close	Closes the Tools menu.
Picture Mode	See page 27.
Sound Mode	See page 29.
Motion Enhancer	See page 33.
Speaker	See page 35.
Twin Picture (except PC input mode)	See page 21.
PIP (in PC input mode only)	See page 22.
Auto Adjustment (in PC input mode only)	See page 32.
Horizontal Shift (in PC input mode only)	See page 32.
 Volume	See page 35.
Sleep Timer (except PC input mode)	See page 36.
Power Saving	See page 37.

To view two pictures simultaneously – Twin Picture

You can view two TV programme pictures (in analogue, digital or external input mode) on the screen simultaneously.

Connect the optional equipment (page 18), and make sure that images from the equipment appear on the screen (page 21).



- Two pictures having the same (analogue or digital) format, cannot be seen side-by-side in Twin Picture mode.
- This function is not available for a PC input source.
- You cannot change the size of the pictures.

1 Press .

The audible picture is framed in green.

2 Press number buttons or PROG +/- to select the channel for an audible picture. Press for an inaudible picture.

To return to normal TV mode

Press  or RETURN.



- You can switch the audible picture by pressing .
- Pictures input through the HDMI and component jacks are displayed on the left screen.

Continued

To view two pictures simultaneously – PIP (Picture in Picture) (in PC mode only)

You can view two pictures (PC input and TV programme) on the screen simultaneously.

To view a PC input source, connect a PC (page 18), and make sure that images from the PC appear on the screen.

1 Press .

Two pictures are displayed simultaneously.

The picture from the connected PC is displayed with full size and the TV programme is displayed on the right corner.

You can use  to move the TV programme screen position.

2 Press number buttons or PROG +/- to select the TV channel.

To return to single picture mode

Press RETURN.



- You can switch the audible picture by selecting “TV Sound / PC Sound” from the Tools menu.
- You can also use the PIP feature by selecting “PIP” from the Tools menu.

Using the remote

Buttons for using optional equipment

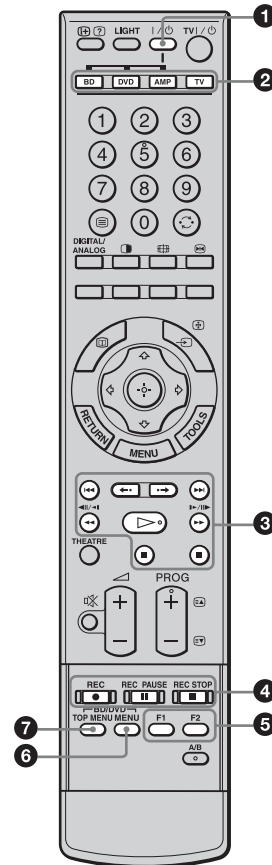









1

Turns on or off the optional equipment selected from the function buttons.

2 **Function buttons**

Enables you to operate the corresponding equipment. For details, see “Programming the remote” on page 23.

3 **BD/DVD operating buttons**

-  : Replays the current programme from the previous chapter mark (if any).
-  : Advances forward to the next chapter mark (if any).
-  : Replays the current programme for a set period of time.
-  : Advances forward a set period of time.
-  : Plays a programme in fast reverse mode.
-  : Plays a programme in fast forward mode.
-  : Plays a programme at a normal speed.
-  : Pauses playback.
-  : Stops the playback.

4 DVD record buttons

- REC: Starts recording.
- ▬ REC PAUSE: Pauses the recording.
- REC STOP: Stops the recording.

5 F1/F2

- Selects a disc when using a DVD changer.
- Selects a function when using a combination unit (e.g. a BD/DVD).

For details, see the operating instructions supplied with the DVD changer or combination unit.

6 BD/DVD MENU

Displays the DVD disc menu. For details, see the operating instructions supplied with the connected equipment.

7 BD/DVD TOP MENU

Displays the top menu of the DVD disc. For details, see the operating instructions supplied with the connected equipment.



The ▷ button has a tactile dot. Use the tactile dot as a reference when operating other equipment.

Programming the remote

This remote is preset to operate Sony TVs, most Sony BDs, DVDs and AMPs (Home Theatre, etc.). To control BDs and DVDs of other manufacturers (and some other Sony BD, DVD and AMP models), do the following procedure to programme the remote.



Before you start, look up the three-digit code for your brand of BD, DVD or AMP from the “Manufacturer’s codes” on page 23.

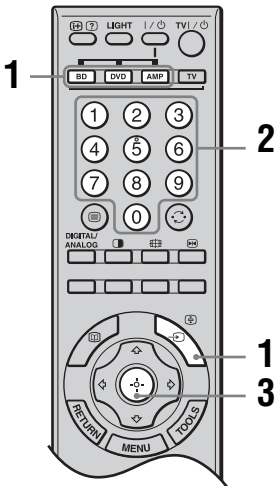

1 Press and hold the BD, DVD or AMP function button you want to programme on the remote, then press /⊕, keeping the function button pressed down.

The selected function button (BD, DVD or AMP) will flash.

2 Press the number buttons to enter the three-digit manufacturer’s code number when the button flashes.

If code is not entered within 10 seconds, you must perform the step 1 again.

3 Press ⊕.

When the programming is correct, the selected function button will flash twice, and when not, it will flash five times.

4 Turn on your equipment and check that the following main functions work.

▷ (playback), ■ (stop), ◀◀ (rewind), ▶▶ (fast forward), channel selection for both BDs and DVDs, TOP MENU/MENU and ↕/↔/↔/↔ only for DVDs.

If your equipment is not working, or some of the functions do not work

Enter the correct code or try the next code listed for the brand. However, not all models of every brand may be covered.

To return to normal TV operation

Press the TV function button.

Manufacturer’s codes

DVD brand list

DVD Player

Brand	Code
SONY	001, 029, 030, 036 – 044, 053 – 055
AIWA	021
AKAI	032
DENON	018, 027, 020, 002
GRUNDIG	009, 028, 023, 024, 016, 003
HITACHI	025, 026, 015, 004, 035
JVC	006, 017
KENWOOD	008
LG	015, 014, 034
LOEWE	009, 028, 023, 024, 016, 003
MATSUI	013, 016
ONKYO	022, 033
PANASONIC	018, 027, 020, 002, 045 – 047

Continued

Brand	Code
PHILIPS	009, 028, 023, 024, 016, 003, 031
PIONEER	004, 050, 051, 052
SAMSUNG	011, 014
SANYO	007
SHARP	019, 027
THOMSON	012
TOSHIBA	003, 048, 049
YAMAHA	018, 027, 020, 002

BD (Blu-ray Disc) Player

Brand	Code
SONY	101 – 103

DVD/VCR Player

Brand	Code
SONY	251

DVD recorder

Brand	Code
SONY	201 – 203

VCR brand list

Brand	Code
SONY	301 – 310, 362
AIWA	325, 331, 351
AKAI	326, 329, 330
DAEWOO	342, 343
GRUNDIG	358, 355, 360, 361, 320, 351, 366
HITACHI	327, 333, 334
JVC	314, 315, 322, 344, 352 – 354, 348, 349
LG	332, 338
LOEWE	358, 355, 360, 361, 320, 351
MATSUI	356, 357
ORION	328
PANASONIC	321, 323
PHILIPS	311 – 313, 316 – 318, 358, 359, 363, 364
SAMSUNG	339 – 341, 345

Brand	Code
SANYO	335, 336
SHARP	324
THOMSON	319, 350, 365
TOSHIBA	337

AUX Sony systems brand list

DAV Home Theatre System

Brand	Code
SONY (DAV)	401 – 404

AV receiver

Brand	Code
SONY	451 – 454

Digital terrestrial receiver

Brand	Code
SONY	501 – 503

Using USB photo viewer

You can view photographs (in JPEG format) stored in a Sony digital still camera, camcorder or USB storage media on your TV.

- 1 Connect a supported USB device to the TV.
- 2 Press MENU.
- 3 Press \uparrow/\downarrow to select "Photo", then press \oplus . The thumbnail screen appears.
- 4 Press $\uparrow/\downarrow/\leftarrow/\rightarrow$ to select the photograph or folder you want to view, and then press \oplus .
If you want to view a slide show, press \leftarrow/\rightarrow to select "Slide Show", then press \oplus .

Advanced operations

Press \leftarrow/\rightarrow to select an option, then press \oplus .

Options	Description
Device Selection	Select the device if multiple devices are connected.
Picture Settings	You can make "Backlight" (page 27), "Picture" (page 27) and "Colour Temperature" settings.
Set-up	You can make advanced settings for the slide show and set the display sequence for the thumbnails.



- USB photo viewer only supports DCF-compliant JPEG photographs.
- Set the camera's USB connection mode to Auto or "Mass Storage" mode when you are connecting Sony digital still camera. For more information about USB connection mode, see the instructions supplied with the device that you use.
- Do not turn off the TV or connected USB device, or disconnect the USB cable or remove the recording media while the data on the recording media is being accessed. The data on the recording media may be damaged.
- Using unsupported USB device is not guaranteed and may cause malfunctions.
- Sony cannot be held liable for any damage to or loss of data on the recording media due to a malfunction of any connected devices or the TV.
- Check the website below for the up to date information about compatible USB devices.
<http://www.sony-asia.com/bravia/flash.html>

Using HDMI control

The HDMI control function allows equipment to control each other using HDMI CEC (Consumer Electronics Control) specified by HDMI.

You can connect Sony HDMI control compatible equipment such as TVs, hard disk DVD recorders and audio systems (with HDMI cables) to let them work integratedly.

Be sure to correctly connect and set the compatible equipment to use the HDMI control function.

To connect the HDMI control compatible equipment

Connect the compatible equipment and the TV with an HDMI cable. When connecting an audio system, in addition to the HDMI cable, be sure to also connect the DIGITAL OUT (OPTICAL) jack of the TV and the audio system using an optical audio cable. For details, see page 18.

To make the HDMI control settings

HDMI control must be set on both the TV side and the connected equipment side. See "HDMI Set-up" on page 37 for the TV side settings. See the operating instructions of the connected equipment for setting details.

HDMI control functions

- Turns the connected equipment automatically off when you turn the TV off.
- Turns the TV on and automatically switches the input to the connected equipment when the equipment starts to play.
- If you turn on a connected audio system while the TV is on, the sound output switches from the TV speaker to the audio system.
- Adjusts the volume and mutes the sound of a connected audio system.

Using Menu Functions

Navigating through menus

Menu functions allow you to enjoy various convenient features of this TV. You can easily select channels or inputs sources and change the settings for your TV.

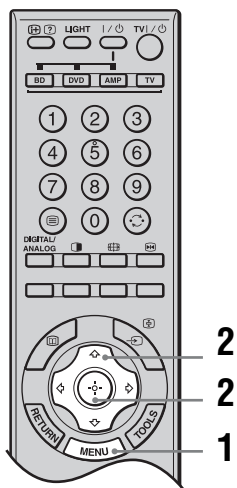

- 1 Press MENU.
- 2 Press \uparrow/\downarrow to select an option, then press \oplus .
To exit the menu, press MENU.

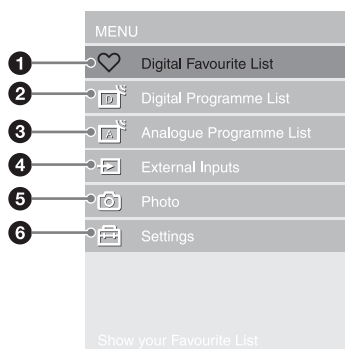

- 1 **Digital Favourite List***
Displays the Favourite List (page 17).
- 2 **Digital Programme List***
Displays available digital TV channels.
- 3 **Analogue Programme List**
Displays available analogue TV channels.
 - To assign a label to a channel, see page 39.

4 External Inputs

Selects equipment connected to your TV.

- To watch the desired external input, select the input source, then press \oplus .
- To assign a label to an external input, select “Edit Video Labels” (page 36).
- To select the connected HDMI control compatible equipment, select “HDMI Device Selection”.

5 Photo

The thumbnail screen appears (page 25).

6 Settings

Displays the “Settings” menu where most of the advanced settings and adjustments are performed.

1 Press \uparrow/\downarrow to select a menu icon, then press \oplus .

2 Press $\uparrow/\downarrow/\leftarrow/\rightarrow$ to select an option or adjust a setting, then press \oplus .

For details about settings, see pages 27 to 42.



The options you can adjust vary depending on the situation. Unavailable options are greyed out or not displayed.

* This function may not be available in some areas.

Picture menu

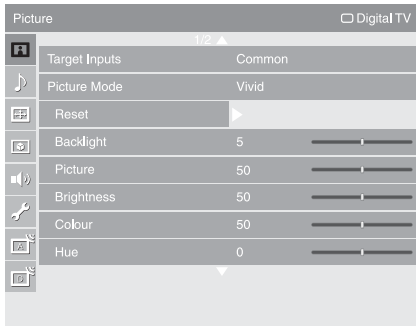

You can select the options listed below on the “Picture” menu. To select options in “Settings”, refer to “Navigating through menus” (page 26).

Target Inputs

For the input currently being viewed, select whether to use the common setting or to set each item separately.

“**Common**”: Applies common settings whose adjustments are shared with other inputs in which “Target Inputs” is set to “Common”.

“**Current input name (e.g. Video 1)**”: Allows you to set each option separately for the current input.



Set each input to “Common” if you require the same settings to apply to each input.

Picture Mode

Selects the picture mode. The options for “Picture Mode” may differ depending on the “Video/Photo” setting (page 33).

“**Vivid**”: For enhanced picture contrast and sharpness.

“**Standard**”: For standard picture. Recommended for home entertainment.

“**Cinema**”: For viewing film-based contents. Most suitable for viewing in a theatre-like environment.

“**Photo**”: Sets the optimum picture quality for photographs.

“**Custom**”: Allows you to store your preferred settings.

Reset

Resets all the “Picture” settings except “Target Inputs”, “Picture Mode” and “Advanced Settings” to the factory settings.

Backlight

Adjusts the brightness of the backlight.

Picture

Increases or decreases picture contrast.

Brightness

Brightens or darkens the picture.

Colour

Increases or decreases colour intensity.

Hue

Increases or decreases the green tones and red tones.



“Hue” can only be adjusted for an NTSC colour system (e.g. U.S.A. video tapes).

Colour Temperature	<p>Selects the picture whiteness option.</p> <p>“Cool”: Gives the white colours a blue tint.</p> <p>“Neutral”: Gives the white colours a neutral tint.</p> <p>“Warm 1”/“Warm 2”: Gives the white colours a red tint. “Warm 2” gives a redder tint than “Warm 1”.</p> <p></p> <p>“Warm 1” and “Warm 2” are not available when “Picture Mode” is set to “Vivid”.</p>
Sharpness	<p>Sharpens or softens the picture.</p>
Noise Reduction	<p>Reduces the picture noise (snowy picture) in a weak broadcast signal.</p> <p>“Auto”: Automatically reduces the picture noise (in analogue TV mode or Video 1/2/3 composite and S video input signals only).</p> <p>“High”/“Medium”/“Low”: Modifies the effect of the noise reduction.</p> <p>“Off”: Turns off the “Noise Reduction” feature.</p>
MPEG Noise Reduction	<p>Reduces the picture noise in MPEG-compressed video.</p>
DRC Mode	<p>Produces a high-resolution picture for high-density sources (e.g., Blu-ray disc player, DVD player, satellite receiver).</p> <p>“Mode 1”: Recommended mode.</p> <p>“Mode 2”: Only available for 1080i format. “Mode 2” is especially effective when original standard-definition signals have been up-converted to 1080i format.</p> <p>“Off”: Turns off the “DRC Mode”.</p>
DRC Palette	<p>Customizes the level of detail (“Reality”) and smoothness (“Clarity”) for each input signal. For example, you can create a custom setting for your cable input’s picture, and create another for your DVD player’s pictures.</p> <p>The “DRC Palette” appears. Press $\uparrow/\downarrow/\leftarrow/\rightarrow$ to adjust the position of the marker (●). As you move the ● higher along the “Reality” axis, the picture becomes more detailed. As you move the ● to the right along the “Clarity” axis, the picture becomes smoother.</p>
Advanced Settings	<p>Customizes the Picture function in more detail. When you set “Picture Mode” to “Vivid”, you cannot set/change these settings.</p> <p>“Reset”: Resets all the advanced settings to the factory settings.</p> <p>“Black Corrector”: Enhances black areas of the picture for stronger contrast.</p> <p>“Adv. Contrast Enhancer”: Automatically adjusts “Backlight” and “Picture” to the most suitable settings judging from the brightness of the screen. This setting is especially effective for dark images scenes. It will increase the contrast distinction of the darker picture scenes.</p> <p>“Gamma”: Adjusts the balance between bright and dark areas of the picture.</p> <p>“Clear White”: Emphasizes white colours.</p> <p>“Colour Space”: Changes the colour reproduction gamut. “Wide” reproduces the vivid colour and “Standard” reproduces the standard colour.</p> <p>“Live Colour”: Makes colours more vivid.</p> <p>“White Balance”: Adjusts the colour temperature colour by colour.</p> <p>“Detail Enhancer”: Enhances the details of the picture.</p> <p>“Edge Enhancer”: Enhances the outline of the picture.</p>

Sound menu

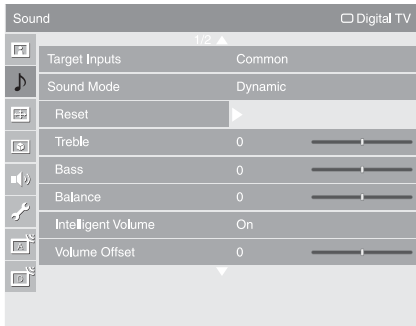

You can select the options listed below on the “Sound” menu. To select options in “Settings”, refer to “Navigating through menus” (page 26).

Target Inputs

For the input currently being viewed, select whether to use the common setting or to set each item separately.

“Common”: Applies common settings whose adjustments are shared with other inputs in which “Target Inputs” is set to “Common”.

Current input name (e.g. Video 1): Allows you to set each option separately for the current input.



Set each input to “Common” if you require the same settings to apply to each input.

Sound Mode

“Dynamic”: Enhances treble and bass.

“Standard”: For standard sound. Recommended for home entertainment.

“Custom”: Flat response. Also allows you to store your preferred settings.

Reset

Resets all the “Sound” settings except “Target Inputs”, “Sound Mode” and “Dual Sound” to the factory settings.

Treble

Adjusts higher-pitched sounds.

Bass

Adjusts lower-pitched sounds.

Balance

Emphasizes left or right speaker balance.

Intelligent Volume

Keeps a constant volume level even when volume level gaps occur (e.g. adverts tend to be louder than programmes).

Volume Offset

Adjusts the volume level of the current input relative to other inputs, when “Target Inputs” is set to the current input name (e.g. Video 1).

Surround

“S-FORCE Front Surround”: Available for normal stereo broadcast and 5.1ch digital broadcast surround audio, and the audio input from connected equipment.

“Simulated Stereo”: Adds a surround-like effect to mono programmes.

“Off”: Converts and reproduces 5.1ch and other digital broadcast surround audio as normal stereo audio (2ch). Reproduces the original audio of other broadcasts as is.

Continued

Voice Zoom

Adjusts the clarity of human voices. For example, if the voice of a news announcer is indistinct, you can turn up this setting to make the voice clearer. Conversely, if you are watching a sports programme, you can turn down this setting to soften the voice of the commentator.

Sound Booster

Gives sound more impact by compensating for phase effects in speakers.

Dual Sound

Selects the sound from the speaker for a stereo or bilingual broadcast. The selection varies, depending on the Broadcasting.

Broadcasting	Selection
NICAM stereo	Stereo (stereo sound) Mono (regular sound)
NICAM bilingual	Main (main sound) Sub (sub sound) Mono (regular sound)
NICAM monaural	Main (main sound) Mono (regular sound)
A2 (German) stereo	Stereo (stereo sound) Mono (regular sound)
A2 (German) bilingual	Main (main sound) Sub (sub sound)



- If the signal is very weak, the sound becomes monaural automatically.
- If the stereo sound is noisy when receiving a NICAM programme, select “Mono”. The sound becomes monaural, but the noise is reduced.
- The “Dual Sound” setting is memorized for each programme position.
- You cannot receive a stereo broadcast signal when “Mono” is selected for the programme position.
- You cannot receive stereo or dual sound when “Low” or “High” is selected in “Audio Filter” (page 40).



If you select other equipment connected to the TV, set “Dual Sound” to “Stereo”, “Main” or “Sub”. However, when the external equipment connected to the HDMI jack is selected, this is fixed to “Stereo” (except when using the audio in jacks).

Screen menu (except for PC input)

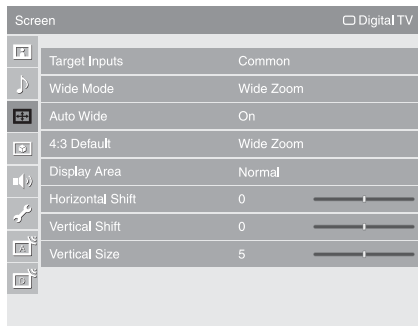

You can select the options listed below on the “Screen” menu. To select options in “Settings”, refer to “Navigating through menus” (page 26).

Target Inputs

For the input currently being viewed, select whether to use the common setting or to set each item separately.

“Common”: Applies common settings whose adjustments are shared with other inputs in which “Target Inputs” is set to “Common”.

Current input name (e.g. Video 1): Allows you to set each option separately for the current input.



Set each input to “Common” if you require the same settings to apply to each input.

Wide Mode

For details about “Wide Mode”, see “To change the Wide Mode manually” on page 15.

Auto Wide

Automatically changes “Wide Mode” according to the broadcast signal. To keep your setting, select “Off”.



Even if “Auto Wide” is set to “On” or “Off”, you can always modify the Wide Mode by pressing  repeatedly.

4:3 Default

Selects the default Wide Mode for use with 4:3 broadcasts.

“Wide Zoom”: Enlarges the 4:3 picture to fill the 16:9 screen, keeping the original image as much as possible.

“Normal”: Displays conventional 4:3 broadcasts in the correct proportions.

“Off”: Keeps the current “Wide Mode” setting when the channel or input is changed.

Display Area

Adjusts the screen area for displaying the picture.

“Full Pixel”: Displays the picture for 1080i or 1080p sources in the original size when parts of the picture are cut off.

“+1”: Displays the original picture area. This setting can be selected for HDMI input signals except for 1080i or 1080p signals.

“Normal”: Displays the recommended picture area.

“-1”/“-2”: Enlarges the picture to hide the edge of the picture.

Horizontal Shift

Adjusts the horizontal position of the picture.

Vertical Shift

Adjusts the vertical position of the picture when “Wide Mode” is set to “Wide Zoom” or “Zoom”.

Vertical Size

Adjusts the vertical size of the picture when “Wide Mode” is set to “Wide Zoom”.

Screen menu (for PC input)

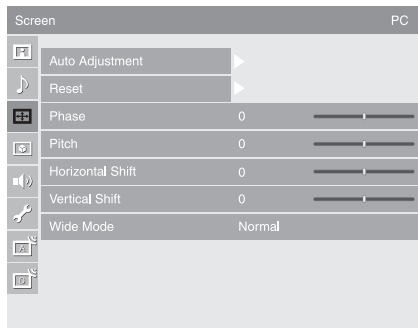

When you select the PC input, you can select the options listed below on the “Screen” menu. To select options in “Settings”, refer to “Navigating through menus” (page 26).

Auto Adjustment

Automatically adjusts the display position, phase and pitch of the picture when the TV receives an input signal from the connected PC.



“Auto Adjustment” may not work well with certain input signals. In such cases, manually adjust “Phase”, “Pitch”, “Horizontal Shift” and “Vertical Shift”.

Reset

Resets all the “Screen” settings for PC input to the factory settings.

Phase

Adjusts the phase when the screen flickers.

Pitch

Adjusts the pitch when the picture has unwanted vertical stripes.

Horizontal Shift

Adjusts the horizontal position of the picture.

Vertical Shift

Adjusts the vertical position of the picture.

Wide Mode

Selects a Wide Mode for displaying input from your PC.

“**Normal**”: Displays the picture in its original size.

“**Full 1**”: Enlarges the picture to fill the vertical display area, keeping its original horizontal-to-vertical aspect ratio.

“**Full 2**”: Enlarges the picture to fill the display area.

Video Settings menu

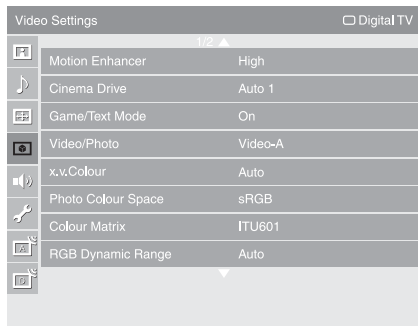

You can select the options listed below on the “Video Settings” menu. To select options in “Settings”, refer to “Navigating through menus” (page 26).

Motion Enhancer

Provides smoother picture movement and reduces picture blur.

“**High**”: Provides smoother picture movement such as for film-based contents.

“**Standard**”: Provides smooth picture movement. Use this setting for standard use.

“**Off**”: Use this setting when the “High” and “Standard” settings result in noise.



Depending on the video, you may not see the effect visually, even if you have changed the setting.

Cinema Drive

Provides improved picture movement when playing DVD or VCR images taken on film, reducing picture blur and graininess.

“**Auto 1**”: Provides smoother picture movement than the original film-based content. Use this setting for standard use.

“**Auto 2**”: Provides the original film-based content as is.

“**Off**”: Turns off the “Cinema Drive” feature.



If the image contains irregular signals or too much noise, “Cinema Drive” will be automatically turned off even if “Auto 1” or “Auto 2” is selected.

Game/Text Mode

Provides the optimum screen for viewing images with fine lines and characters that are input from video game equipment and PCs. Set to “On” for the sharp display of fine lines or characters.

Video/Photo

Provides suitable image quality by selecting the option depending on the input source (video or photograph data).

“**Video-A**”: Sets suitable image quality, depending on the input source, video data or photograph data when directly connecting Sony HDMI output-capable equipment that supports “Video-A” mode.

“**Video**”: Produces suitable image quality for moving pictures.

“**Photo**”: Produces suitable image quality for still images.



The setting is fixed to “Video” when Video-A mode is not supported on the connected equipment, even if “Video-A” is selected.

x.v.Colour

Displays moving pictures that is more faithful to the original source by matching the colour space of source.



The setting is fixed to “Normal” when the input signal is HDMI (RGB), even if “x.v.Colour” is selected.

Photo Colour Space

Selects the option to match the output colour space within the output signal from the equipment connected to the HDMI or component input jacks. Select “sYCC” when using the equipment that supports “x.v.Colour”.



The setting is fixed to “sRGB” when the input signal is HDMI (RGB), even if “sYCC” is selected.

Colour Matrix

Usually used in the factory setting (Video 1, 2, 3 (Composite and S video input signal) is set to “ITU601”, and HD/DVD 1, 2 (Component input signal) is set to “Auto”). If the colour tone of the picture from the input source does not match the colour standard and looks unnatural, select either “ITU601” or “ITU709”, which normalizes the colour tone.

RGB Dynamic Range

Produces natural colour by changing the luminance tone reproduction of HDMI input colour signals (RGB). Set to “Auto” for standard use. Change the settings only when the luminance tone of the display is unnatural.

Colour System

Selects the colour system (“Auto”, “PAL”, “SECAM”, “NTSC3.58” or “NTSC4.43”) according to the input signal from the input source.

Audio Settings menu

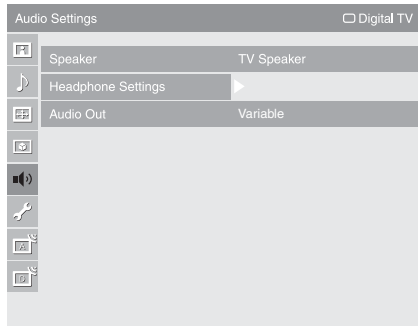

You can select the options listed below on the “Audio Settings” menu. To select options in “Settings”, refer to “Navigating through menus” (page 26).

Speaker

Turns on/off the TV’s internal speakers.

“**TV Speaker**”: The TV speakers are turned on in order to listen to the TV’s sound through the TV speakers.

“**Audio System**”: The TV speakers are turned off in order to listen to the TV’s sound only through your external audio equipment connected to the audio output jacks. When HDMI control compatible equipment is connected, you can turn on the equipment whose operations are linked to the TV. This setting must be made after connecting the equipment.

Headphone Settings

Speaker Link

Switches the TV’s internal speakers on/off when headphones are connected.

“**On**”: Sound is output only from headphones.

“**Off**”: Sound is output from both the TV and headphones.

Volume

Adjusts the volume of the headphones when “ Speaker Link” is set to “Off”.

Audio Out

“**Variable**”: The audio output from your audio system can be controlled by the TV’s remote.

“**Fixed**”: The audio output of the TV is fixed. Use your audio receiver’s volume control to adjust the volume (and other audio settings) through your audio system.

Set-up menu

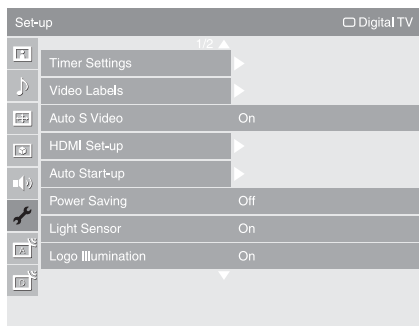

You can select the options listed below on the “Set-up” menu. To select options in “Settings”, refer to “Navigating through menus” (page 26).

Timer Settings

Sets the timer to turn on/off the TV.

Sleep Timer

Sets a period of time after which the TV automatically switches itself into standby mode.

When “Sleep Timer” is activated, the ⏰ (Timer) indicator on the TV front panel lights up in orange.



- If you turn off the TV and turn it on again, “Sleep Timer” is reset to “Off”.
- A notification message appears on the screen one minute before the TV switches to standby mode.

On Timer

Sets the timer to turn on the TV from standby mode.

“**Day**”: Selects the day on which you want to activate the “On Timer”.

“**Time**”: Sets the time to turn on the TV.

“**Duration**”: Selects the time period after which the TV automatically switches to standby mode again.

“**Volume Set-up**”: Sets the volume for when the timer turns on the TV.

Clock Set

Sets the clock using the following menu selections in “Time Adjustment”.

“**Auto**”: The clock is set automatically when a digitally broadcast time signal is received.

“**Manual**”: Sets the clock manually when digital channels have not been stored, or when you cannot receive the time correctly. Set the “Day” and “Time”.

Video Labels

Assigns a name to any equipment connected to the side and rear jacks. The name will be displayed briefly on the screen when the equipment is selected. You can skip input signals from connected equipment that you do not want displayed on the screen.







1 Press \uparrow/\downarrow to select the desired input source, then press \oplus .

2 Press \uparrow/\downarrow to select the desired option below, then press \oplus .

Equipment labels: Uses one of the preset labels to assign a name to connected equipment.

“**Edit**”: Creates your own label. Follow steps 2 to 4 of “Programme Labels” (page 39).

“**Skip**”: Skips an unnecessary input source.

Auto S Video	<p>Selects the input signal from S video jacks S- 1 or 2 when S-/ 1 or 2 jacks are both connected.</p> <p>“On”: Switches automatically between the S video jack and the composite video jacks depending on the cable connection.</p> <p>“Off”: Activates the composite video jacks.</p>
HDMI Set-up	<p>This is used to set the HDMI control compatible equipment connected to the HDMI jacks. Note that the link setting must also be made on the side of the HDMI control compatible equipment that is connected.</p> <p>HDMI Control Sets whether or not to link the operations of the HDMI control compatible equipment and the TV. When set to “On”, the following menu items can be performed.</p> <p>Auto Devices Off When this is set to “On”, any connected HDMI control compatible equipment will be turned off with the TV.</p> <p>Auto TV On When this is set to “On”, the TV turns on when any connected HDMI control compatible equipment is turned on.</p> <p>HDMI Device List Displays the connected HDMI control compatible equipment.</p> <p> You cannot use “HDMI Control” if the TV operations are linked to the operations of an audio system that is compatible with HDMI control.</p>
Auto Start-up	<p>Starts the initial set-up to tune in all available digital and analogue channels and set the time.</p> <p>Usually, you do not need to do this operation because channels already tuned when the TV was first installed (page 6).</p> <p>However, this option allows you to repeat the process (e.g. to retune the TV after moving house, or to search for new channels that have been launched by broadcasters).</p>
Power Saving	<p>Selects the power saving mode to reduce the power consumption of the TV.</p> <p>When “Picture Off” is selected, the picture is switched off and the  (Picture Off) indicator on the TV front panel lights up in green. The sound remains unchanged.</p>
Light Sensor	<p>“On”: Automatically optimises the picture settings according to the ambient light in the room.</p> <p>“Off”: Turns off the “Light Sensor” feature.</p> <p> Be sure not to put anything over the sensor, as its function may be affected. See page 13 for further information on the sensor.</p>
Logo Illumination	<p>Lights up and turns off the Sony logo on the front of the TV.</p>
PC Power Management	<p>Switches the TV to standby mode if no signal is received for 30 seconds in the PC input.</p>
Product Information	<p>Displays your TV’s product information.</p>

Continued

All Reset

Resets all settings to the factory settings and then displays the “Auto Start-up” screen.



- Be sure not to turn the TV off during this period (it takes about 30 seconds) or press any buttons.
- All settings, including Favourite List, auto tuned channels, etc. will be reset.

Analogue Set-up menu

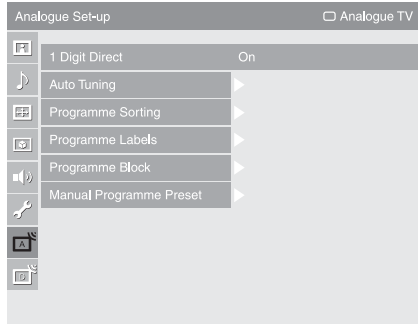

You can select the options listed below on the “Analogue Set-up” menu. To select options in “Settings”, refer to “Navigating through menus” (page 26).

1 Digit Direct

When “1 Digit Direct” is set to “On”, you can select an analogue channel using one preset number button (0 – 9) on the remote.



When “1 Digit Direct” is set to “On”, you cannot select channel numbers 10 and above entering two digits using the remote.

Auto Tuning

Tunes in all the available analogue channels.

This option allows you to retune the TV after moving house, or to search for new channels that have been launched by broadcasters.

Programme Sorting

Changes the order in which the analogue channels are stored on the TV.

- 1 Press \uparrow/\downarrow to select the channel you want to move to a new position, then press \oplus .
- 2 Press \uparrow/\downarrow to select the new position for your channel, then press \oplus .

Programme Labels

Assigns a channel name of your choice up to five letters or numbers. The name will be displayed briefly on the screen when the channel is selected. (Names for channels are usually taken automatically from Text (if available).)

- 1 Press \uparrow/\downarrow to select the channel you want to name, then press \oplus .
- 2 Press \uparrow/\downarrow to select the desired letter or number (“_” for a blank space), then press \Rightarrow .

If you input a wrong character

Press \Leftarrow/\Rightarrow to select the wrong character. Then, press \uparrow/\downarrow to select the correct character.

To delete all the characters

Select “Reset”, then press \oplus .

- 3 Repeat the procedure in step 2 until the name is completed.
- 4 Select “OK”, then press \oplus .

Programme Block

Blocks an individual channel from being watched.

- 1 Press \uparrow/\downarrow to select the channel you want to block, then press \oplus .
- 2 Press \uparrow/\downarrow to select “Block”, then press \oplus .
To watch the channel, select “Allow”.

Manual Programme Preset

Before selecting “Label”/“AFT”/“Audio Filter”/“Skip”/“Colour System”, press PROG +/- to select the programme number with the channel. You cannot select a programme number that is set to “Skip” (page 40).

Programme/TV System

Presets programme channels manually.

- 1 Press \uparrow/\downarrow to select “Programme”, then press \oplus .
- 2 Press \uparrow/\downarrow to select the programme number you want to manually tune (if tuning a VCR, select channel 00), then press \oplus .
- 3 Press \uparrow/\downarrow to select “TV System”, then press \oplus .
- 4 Press \uparrow/\downarrow to select the best received TV broadcast systems, then press \oplus .
- 5 Press \uparrow/\downarrow to select “VHF Low”, “VHF High” or “UHF” then press \oplus .
- 6 Press \leftarrow/\rightarrow until the desired channel’s broadcast appears on the TV screen, then press \oplus .

Label

Assigns a name of your choice, up to five letters or numbers, to the selected channel. This name will be displayed briefly on the screen when the channel is selected. To input characters, follow steps 2 to 4 of “Programme Labels” (page 39).

AFT

Allows you to fine-tune the selected programme number manually if you feel that a slight tuning adjustment will improve the picture quality.

You can adjust the fine tuning over a range of -15 to +15. When “On” is selected, the fine tuning is performed automatically.

Audio Filter

Improves the sound for individual channels in the case of distortion in mono broadcasts. Sometimes a non-standard broadcast signal can cause sound distortion or intermittent sound muting when watching mono programmes.

If you do not experience any sound distortion, we recommend that you leave this option set to the factory setting “Off”.



You cannot receive stereo or dual sound when “Low” or “High” is selected.

Skip

Skips unused analogue channels when you press PROG +/- to select channels. (You can still select a skipped channel using the number buttons.)

Colour System

Selects the colour system (“Auto”, “PAL”, “SECAM”, “NTSC3.58”, or “NTSC4.43”) according to the channel.

Signal Level

Displays the signal level for programme currently being watched.

Digital Set-up menu DV3

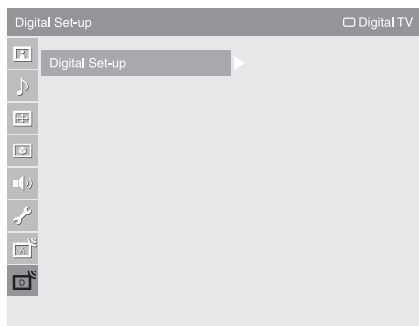

You can select the options listed below on the “Digital Set-up” menu. To select options in “Settings”, refer to “Navigating through menus” (page 26).



Some functions may not be available in some areas.

Digital Settings

Displays the “Digital Settings” menu.

Audio Set-up

This option enables you to enjoy audio in various environments.

“Audio Output Control”: Sets the priority for digital audio output (optical) (when “Dolby Digital” and “MPEG” audio are available).

“MPEG Audio Adjustment”: Adjusts MPEG audio Control level to Dolby Digital audio level.

Time Set-up

Sets the time zone in which you are using the TV. For details, refer to “Auto-tuning the TV” on page 7.

Digital Tuning

Displays the “Digital Tuning” menu.

Full Scan

Tunes in all the available digital channels.

Usually you do not need to do this operation because the channels were already tuned when the TV was first installed (page 6). However, this option allows you to repeat the process (e.g. to retune the TV after moving house, or to search for new channels that have been launched by broadcasters). For details, refer to “Auto-tuning the TV” on page 7.

Quick Scan

Tunes in all the expected digital channels in your area.

Usually you do not need to do this operation because the channels were already tuned when the TV was first installed (page 6). However, this option allows you to repeat the process (e.g. to retune the TV after moving house, or to search for new channels that have been launched by broadcasters). For details, refer to “Auto-tuning the TV” on page 6.

Manual Scan

This option allows channels to be manually tuned and stored. Due to the technical nature of the settings, it is recommended that only experienced service personnel use this option.

Favourite Preset

Presets Favourite List 1 and Favourite List 2.

- 1 Press \uparrow/\downarrow to select "Favourite List 1" or "Favourite List 2", then press \oplus .
- 2 Press \uparrow/\downarrow to select the desired allocation number, then press \oplus .
- 3 Press \uparrow/\downarrow to select the channel you want to allocate, then press \oplus .

To overwrite a new channel selection (over one that has been pre-allocated), follow step 3 to select the newly desired channel, then press \oplus .

To delete a pre-allocated channel, follow step 2 (to select the desired channel), then select "Delete" in step 3.

Parental Control

Sets a parental guidance level. Programmes that exceed the set level can only be watched after entering the correct password. The password is initially set to "0000". If you want to change the password, follow "To change the password" (see below).











- 1 Press the number buttons to enter your password.
- 2 Press \uparrow/\downarrow to select "Parental Rating", then press \oplus .
- 3 Press \uparrow/\downarrow to select the level you want to set (refer to the table below), then press \oplus .

Level	Function
Block All	All programmes need a password to view.
Block G and above	To lock "General" and above programmes.
Block PG and above	To lock "Parental Guidance" and above programmes.
Block M and above	To lock "Mature" and above programmes.
Block MA and above	To lock "Mature Adult" and above programmes.
Block AV and above	To lock "Adult/Violence" and above programmes.
Block R and above	To lock "Restricted" and above programmes.
No Block (default setting)	No programmes need a password to view.

To change the password

Select "Change Password" in step 2 above, then press \oplus . Enter the new password using the number buttons. Enter the new password again.

Specifications

Model name	KDL-40XBR/40X3100	KDL-46XBR/46X3100	KDL-52XBR/52X3100	
System				
Panel System	LCD (Liquid Crystal Display) Panel			
TV System	Analogue: I, D/K, B/G, M Digital: DVB-T			
Colour/Video System	Analogue: PAL, SECAM, NTSC 3.58, NTSC 4.43 (only Video In) Digital: MP@HL and MP@ML			
Channel Coverage	Analogue: B/G: VHF: E2 to E12 / UHF: E21 to E69 /CATV: S01 to S03, S1 to S41 VHF: 0 to 12, 5A, 9A / UHF: 28 to 69 /CATV: S01 to S03, S1 to S44 (Australia only) VHF: 1 to 11 / UHF: 21 to 69 /CATV: S01 to S03, S1 to S41(New Zealand only) I: UHF: B21 to B69 / CATV: S01 to S03, S1 to S41 D/K: VHF: C1 to C12, R1 to R12 /UHF: C13 to C57, R21 to R60 /CATV: S01 to S03, S1 to S41, Z1 to Z39 M: VHF: A2 to A13 / UHF: A14 to A79 /CATV: A-8 to A-2, A to W+4, W+6 to W+84 Digital: VHF/UHF			
Sound Output	11 W + 11 W			
Input/Output jacks				
Antenna	75 ohm external terminal for VHF/UHF			
 1, 2	S video input (4-pin mini DIN)			
 1, 2, 3	Video input (phono jack)			
 1, 2, 3	Audio input (phono jacks): 500 mVrms, Impedance: 47 kilohms			
 1/2	Supported formats: 1080p, 1080i, 720p, 576p, 576i, 480p, 480i Y: 1 Vp-p, 75 ohms, 0.3V negative sync/Pb/Cb: 0.7 Vp-p, 75 ohms/ Pr/Cr: 0.7 Vp-p, 75 ohms			
HDMI IN 1, 2, 3	Video: 1080/24p, 1080p, 1080i, 720p, 576p, 576i, 480p, 480i Audio: Two channel linear PCM 32, 44.1 and 48 kHz, 16, 20 and 24 bits Analogue audio input (phono jacks): 500 mVrms, Impedance: 47 kilohms (HDMI IN 1 only)			
	Video output (phono jack)			
	DIGITAL OUT (OPTICAL) (digital optical jack)/Audio output (phono jacks)			
PC IN  (RGB)	PC Input (D-sub 15-pin) (see page 44) G: 0.7 Vp-p, 75 ohms, non Sync on Green/B: 0.7 Vp-p, 75 ohms/ R: 0.7 Vp-p, 75 ohms/HD: 1-5 Vp-p/VD: 1-5 Vp-p -  PC audio input (minijack)			
	Headphones jack			
	USB port			
Power and others				
Power Requirements	220–240 V AC, 50 Hz			
Screen Size	40 inches (Approx. 101.6 cm measured diagonally)	46 inches (Approx. 116.8 cm measured diagonally)	52 inches (Approx. 132.2 cm measured diagonally)	
Display Resolution	1,920 dots (horizontal) × 1,080 lines (vertical)			
Power Consumption	260 W	300 W	350 W	
Standby Power Consumption*	0.3 W			
Dimensions (w × h × d)	(with stand)	Approx. 1,111 × 717 × 322 mm	Approx. 1,262 × 795 × 322 mm	Approx. 1,415 × 890 × 384 mm
	(without stand)	Approx. 1,111 × 657 × 123 mm/ Approx. 1,111 × 657 × 121 mm	Approx. 1,262 × 734 × 123 mm/ Approx. 1,262 × 734 × 121 mm	Approx. 1,415 × 827 × 125 mm/ Approx. 1,415 × 827 × 123 mm
Mass	(with stand)	Approx. 31.0 kg	Approx. 38.0 kg	Approx. 49.0 kg
	(without stand)	Approx. 26.0 kg	Approx. 33.0 kg	Approx. 42.0 kg
Supplied Accessories	Refer to “1: Checking the accessories” on page 4.			
Optional Accessories	Wall-Mount Bracket SU-WL500			
	Colour Variation Unit CRU-40X1 (for KDL-40X3100)	Colour Variation Unit CRU-46X1 (for KDL-46X3100)	Colour Variation Unit CRU-52X1 (for KDL-52X3100)	

* Specified standby power is reached after the TV finishes necessary internal processes.

Design and specifications are subject to change without notice.

Continued

PC Input Signal Reference Chart

Signals	Horizontal (Pixel)	Vertical (Line)	Horizontal frequency (kHz)	Vertical frequency (Hz)	Standard
VGA	640	480	31.5	60	VGA
	640	480	37.5	75	VESA
	720	400	31.5	70	VGA-T
SVGA	800	600	37.9	60	VESA Guidelines
	800	600	46.9	75	VESA
XGA	1024	768	48.4	60	VESA Guidelines
	1024	768	56.5	70	VESA
	1024	768	60.0	75	VESA
WXGA	1280	768	47.4	60	VESA
	1280	768	47.8	60	VESA
	1280	768	60.3	75	
	1360	768	47.7	60	VESA
SXGA	1280	1024	64.0	60	VESA
	1280	1024	80.0	75	VESA
HDTV	1920	1080	67.5	60	

- This TV's PC input does not support Sync on Green or Composite Sync.
- This TV's PC input does not support interlaced signals.
- For the best picture quality, it is recommended to use the signals (boldfaced) in the above chart with a 60 Hz vertical frequency from a personal computer. In plug and play, signals with a 60 Hz vertical frequency will be selected automatically.

i-Plate Display Language Code

Code	Language	Code	Language	Code	Language	Code	Language
Af	Afrikaans	El	Greek	Ita	Italian	Spa	Spanish
Afr	Afrikaans	Ell	Greek	Jpn	Japanese	Tam	Tamil
Ar	Arabic	En	English	Kan	Kannada	Tel	Telugu
Ara	Arabic	Eng	English	Kor	Korean	Zho	Chinese
Aus	Australian	Fr	French	Mal	Malayalam	U1	Unknown 1
Ben	Bengali	Fra	French	Nl	Dutch	U2	Unknown 2
Bn	Bengali	Fre	French	Nld	Dutch		
Chi	Chinese	Gem	German	Pan	Panjabi		
De	German	Ger	German	Por	Portuguese		
Deu	German	Gre	Greek	Raj	Rajasthani		
Dut	Dutch	Hi	Hindi	Rus	Russian		
Egy	Egyptian	Hin	Hindi	San	Sanskrit		

Cleaning

Clean the ventilation holes of this TV set regularly (once a month). If dust accumulates, the cooling fan may not operate properly.

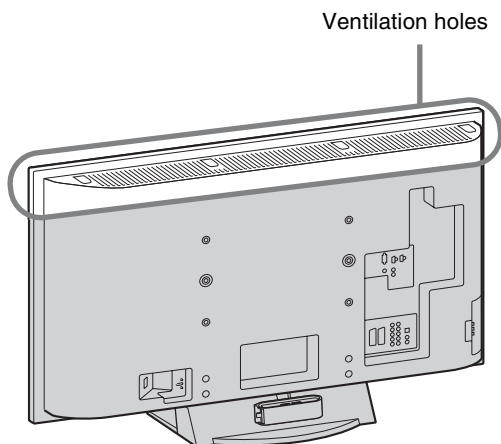



Troubleshooting

Check whether the  (standby) indicator is flashing in red.

When it is flashing

The self-diagnosis function is activated.



- 1 Count how many  (standby) indicator flashes between each two second break.
For example, the indicator flashes three times, then there is a two second break, followed by another three flashes, etc.
- 2 Press  on the right side of the TV to turn it off, disconnect the AC power cord, and inform your dealer or Sony service centre of how the indicator flashes (number of flashes).

When it is not flashing

- 1 Check the items listed below.
- 2 If the problem still persists, have your TV serviced by qualified service personnel.

Picture

No picture (screen is dark) and no sound

- Check the antenna connection.
- Connect the TV to the AC power outlet, and press  on the right side of the TV.
- If the  (standby) indicator lights up in red, press TV .

No picture or no menu information from equipment connected to the video input jack

- Press  to display the connected equipment list, then select the desired input.
- Check the connection between the optional equipment and the TV.

Double images or ghosting

- Check the antenna connection.
- Check the antenna location and direction.

Only snow and noise appear on the screen

- Check if the antenna is broken or bent.
- Check if the antenna has reached the end of its serviceable life (three to five years in normal use, one to two years at the seaside).

Distorted picture (dotted lines or stripes)

- Keep the TV away from electrical noise sources such as cars, motorcycles, hair-dryers or optical equipment.
- When installing optional equipment, leave some space between the optional equipment and the TV.
- Make sure that the antenna is connected using the supplied antenna cable.
- Keep the antenna cable away from other connecting cables.

Picture or sound noise when viewing a TV channel

- Adjust "AFT" (Automatic Fine Tuning) to obtain better picture reception (page 40).

Continued

Some tiny black points and/or bright points appear on the screen

- The picture of a display unit is composed of pixels. Tiny black points and/or bright points (pixels) on the screen do not indicate a malfunction.

No colour on programmes



- Select “Reset” (page 27).

No colour or irregular colour when viewing a signal from the 1 or 2 jacks

- Check the connection of the  1 or 2 jacks and check if each jacks are firmly seated in their respective jacks.

Sound

No sound, but good picture

- Press  +/- or  (Mute).
- Check if the “Speaker” is set to “TV Speaker” (page 35).
- When using HDMI input with Super Audio CD or DVD-Audio, DIGITAL OUT (Optical) may not provide audio signal.

There is a whirring sound

- This is the sound of internal fans of the TV (except for KDL-52XBR/52X3100). This is not a malfunction.

Channels

The desired channel cannot be selected

- Switch between digital and analogue mode and select the desired digital/analogue channel.

Some channels are blank

- Scrambled/Subscription only channel. Subscribe to the pay TV service.
- Channel is used only for data (no picture or sound).
- Contact the broadcaster for transmission details.

Digital channels are not displayed

- Contact a local installer to find out if digital transmissions are provided in your area.
- Upgrade to a higher gain antenna.

Some channels cannot be selected

- Once you select a channel within your Favourite List of channels, pressing PROG +/- will select only channels from your Favourite List. To select a channel that has not been programmed as a Favourite List channel, use the Program List feature or the number buttons.

General

The TV turns off automatically (the TV enters standby mode)

- Check if the “Sleep Timer” is activated, or confirm the “Duration” setting of “On Timer” (page 36).

The TV turns on automatically

- Check if the “On Timer” is activated (page 36).

Some input sources cannot be selected

- Select “Video Labels” and cancel “Skip” of the input source (page 36).

The remote does not function

- Replace the batteries.

The “Store Display Mode: On” message appears on the screen

- Select “All Reset” in the “Set-up” menu (page 38).

The picture contours are disrupted

- Select “Standard” or “Off” in “Motion Enhancer” (page 33).

The recorded images appear enlarged when they are played on a 4:3 screen size TV

- The images of digital broadcasting recorded on this TV appear enlarged when they are played on a 4:3 screen size TV that cannot be adjusted to other aspect modes.

Forgotten Parental Control password

- Select “All Reset” in the “Set-up” menu (page 38).

Weak signal (signal level indicator (page 40) displayed in red)

- Check the antenna connection.



Printed on 70% or more recycled paper.

<http://www.sony.net/>

Printed in Japan



3217284110